

Prima Plus





🇮🇹 Soluzioni e prestazioni per soddisfare le tue esigenze! BI-MATIC dal 1979 definisce standard di questa categoria: grazie alla affidabilità meccanica, l'innovazione e la qualità durevole, diamo ancora punti di riferimento nel settore bordatura in termini di economicità e prestazioni, indipendentemente dal materiale. Fantastico rapporto costo-prestazioni e soprattutto la semplicità di utilizzo e comando.

Dal 1979 EDGE BANDING SOLUTIONS

🇬🇧 Solutions and performance to meet your needs! BI-MATIC since 1979 sets standards in this category: thanks to mechanical reliability, innovation and durable quality, we still give benchmarks in the edging sector in terms of economy and performance, regardless of the material. Fantastic cost-performance ratio and above all the simplicity of use and command. Since 1979 EDGE BANDING SOLUTIONS

🇫🇷 Des solutions et des performances pour répondre à vos besoins! BI-MATIC depuis 1979 établit des standards dans cette catégorie: grâce à la fiabilité mécanique, à l'innovation et à la qualité durable, nous donnons encore des références dans le secteur des bordures en termes d'économie et de performance, quel que soit le matériau. Un rapport coût-performance fantastique et surtout la simplicité d'utilisation et de commande. Depuis 1979 EDGE BANDING SOLUTIONS

🇩🇪 Lösungen und Leistung für Ihre Bedürfnisse! BI-MATIC setzt seit 1979 Maßstäbe in dieser Kategorie: Dank mechanischer Zuverlässigkeit, Innovation und langlebiger Qualität geben wir im Kantbereich unabhängig vom Material immer noch Benchmarks in Wirtschaftlichkeit und Leistung. Fantastisches Preis-Leistungsverhältnis und vor allem die einfache Bedienung und Bedienung. Seit 1979 EDGE BANDING SOLUTIONS

🇳🇱 Oplossingen en prestaties om aan uw behoeften te voldoen! BI-MATIC hanteert sinds 1979 normen in deze categorie: dankzij mechanische betrouwbaarheid, innovatie en duurzame kwaliteit, bieden we nog steeds benchmarks in de randensector in termen van zuinigheid en prestaties, ongeacht het materiaal. Fantastische kosten-prestatieverhouding en vooral de eenvoud van gebruik en commando. Sinds 1979 EDGE BANDING SOLUTIONS

🇪🇸 Soluciones y rendimiento para satisfacer sus necesidades! BI-MATIC desde 1979 establece estándares en esta categoría: gracias a la confiabilidad mecánica, la innovación y la calidad duradera, seguimos dando puntos de referencia en el sector de bordes en términos de economía y rendimiento, independientemente del material. Fantástica relación costo-rendimiento y, sobre todo, simplicidad de uso y comando. Desde 1979 EDGE BANDING SOLUTIONS

🇧🇷 Soluções e desempenho para atender suas necessidades! BI-MATIC desde 1979 estabelece padrões nesta categoria: graças à confiabilidade mecânica, inovação e qualidade durável, ainda damos benchmarks no setor de bordas em termos de economia e desempenho, independentemente do material. Fantástica relação custo-benefício e acima de tudo a simplicidade de uso e comando. Desde 1979, EDGE BANDING SOLUTIONS



- Sistema di comando.
- Semplice menù operativo
 - Veloce accesso al funzionamento dei gruppi operativi
 - Nr. 04 righe di informazione
 - Messaggistica errori e malfunzionamenti



- Control system
- Simple operation menu
 - Rapid access to operation unit
 - Four information lines
 - Error and trouble message system



- Steuersystem
- Einfaches Betriebsmenü
 - Rascher Zugriff auf die Funktionsweise der Betriebsgruppen
 - 04 Informationszeilen
 - Meldung von Fehlern und Störungen



- Système de commande
- Menu opérationnel simple
 - Accès rapide au fonctionnement des groupes opérationnels
 - 4 lignes d'informations
 - Messages pour les erreurs et les dysfonctionnements



- Sistema di comando.
- Display grafico da 12"
 - Semplice e intuitivo menù operativo
 - Sistema di memorizzazione programmi di lavoro
 - Gestione e controllo assi di posizionamento
 - Sistema di back-up dati macchina e programmi
 - Veloce accesso al funzionamento dei gruppi operativi
 - Messaggistica errori e malfunzionamento



- Control system
- 12" Graphic display
 - Simple and user-friendly operation menu
 - Work program saving system
 - Management and control of positioning axes
 - Back-up system of machine data and programs
 - Rapid access to operation unit
 - Error and trouble message system



- An den Maschinen
- 12" Grafikdisplay
 - Einfaches und intuitives Betriebsmenü
 - System zur Speicherung von Arbeitsprogrammen
 - Steuerung und Kontrolle der Positionierungsachsen
 - Backup-System für Maschinendaten und Programme
 - Rascher Zugriff auf die Funktionsweise der Betriebsgruppen.
 - Meldung von Fehlern und Störungen



- Système de commande
- Écran graphique de 12"
 - Menu opérationnel simple et intuitif
 - Système de mémorisation des programmes de travail
 - Gestion et contrôle des axes de positionnement
 - Système de sauvegarde des données machines et des programmes
 - Accès rapide au fonctionnement des groupes opérationnels
 - Messages pour les erreurs et les dysfonctionnements



- Sturingsysteem
- Eenvoudig bedieningsmenu
 - Snelle toegang tot de werkgroepen
 - Vier informatielijnen
 - Meldingen van fouten en onregelmatigheden



- Sistema de control
- Menú operativo simple
 - Acceso rápido al funcionamiento de los grupos operativos
 - Nro. 04 líneas de información
 - Mensajería de errores y fallos de funcionamiento



- Sistema de comando
- Menu operacional simples
 - Acesso rápido ao funcionamento dos conjuntos operacionais
 - 04 linhas de informação
 - Mensagens de erros e maus funcionamentos



- Sturingsysteem
- 12" grafisch scherm
 - Eenvoudig en gebruiksvriendelijk bedieningsmenu
 - Opslag van werkprogramma's
 - Beheer en sturing van positioneringsassen
 - Back-up van machinegegevens en programma's
 - Snelle toegang tot werkgroepen
 - Meldingen van fouten en onregelmatigheden



- Sistema de control
- Pantalla gráfica de 12"
 - Menú operativo simple e intuitivo
 - Sistema de memorización de los programas de trabajo
 - Gestión y control de los ejes de posicionamiento
 - Sistema de salvaguarda de los datos de la máquina y programas
 - Acceso rápido al funcionamiento de los grupos operativos
 - Mensajería de errores y fallos de funcionamiento



- Sistema de comando
- Display gráfico de 12"
 - Menu operacional simples e intuitivo
 - Sistema de memorização dos programas de trabalho
 - Gestão e controlo dos eixos de posicionamento
 - Sistema de back-up dos dados da máquina e programas
 - Acesso rápido ao funcionamento dos conjuntos operacionais
 - Mensagens de erros e maus funcionamentos



Non importa quale sia il materiale del bordo da applicare, la tipologia di colla, bordo coestruso, con la serie Prima Plus di BI-MATIC vogliamo dare una risposta alle esigenze della clientela per realizzare arredi di qualità. Ogni bordatrice della serie Prima Plus deve essere sempre pronta, grazie ai ridotti tempi di riscaldamento del sistema di incollaggio, ma soprattutto in grado di lavorare qualsiasi tipo di materiale! La possibilità di personalizzazione pressoché infinita, la tecnologia applicata, la qualità dei materiali utilizzati, la semplicità d'uso, garantiscono il rapido ritorno dell'investimento.

No matter what material of the edge to apply, the type of glue, coextruded edge, with the Prima Plus series of BI-MATIC we want to give an answer to the needs of customers to create quality furnishings. Each Prima Plus series edge bander must always be ready, thanks to the reduced heating times of the gluing system, but above all able to work any type of material! The possibility of almost infinite customization, the applied technology, the quality of the materials used and the ease of use guarantee a quick return on investment.

Egal, welches Kantenmaterial aufgetragen werden soll, die Art des Leims, die coextrudierte Kante, mit der Prima Plus-Serie von BI-MATIC wollen wir eine Antwort auf die Bedürfnisse der Kunden geben, um eine hochwertige Einrichtung zu schaffen. Jede Kantenanleimmaschine der Prima Plus-Serie muss immer bereit sein, dank der verkürzten Heizzeiten des Klebesystems, aber vor allem in der Lage, jede Art von Material zu bearbeiten! Die nahezu unbegrenzte Anpassbarkeit, die angewandte Technologie, die Qualität der verwendeten Materialien und die Benutzerfreundlichkeit garantieren einen schnellen Return on Investment.

Peu importe le matériau du bord à appliquer, le type de colle, le bord coextrudé, avec la série Prima Plus de BI-MATIC nous voulons donner une réponse aux besoins des clients pour créer un mobilier de qualité. Chaque plaqueuse de chant de la série Prima Plus doit toujours être prête, grâce aux temps de chauffage réduits du système de collage, mais surtout capable de travailler n'importe quel type de matériau! La possibilité de personnalisation quasi infinie, la technologie appliquée, la qualité des matériaux utilisés et la facilité d'utilisation garantissent un retour sur investissement rapide.

Het maakt niet uit welk materiaal van de rand moet worden aangebracht, het type lijm, gecoëxtrudeerde rand, met de Prima Plus-reeks BI-MATIC willen we een antwoord geven op de behoeften van klanten om kwaliteitsmeubilair te maken. Elke Edge-bander uit de Prima Plus-reeks moet altijd gereed zijn, dankzij de kortere verwarmingstijden van het lijmsysteem, maar bovenal in staat om elk type materiaal te bewerken! De mogelijkheid van bijna oneindige maatwerk, de toegepaste technologie, de kwaliteit van de gebruikte materialen en het gebruiksgemak garanderen een snel rendement op uw investering.

No importa qué material de borde aplicar, el tipo de pegamento, borde coextruido, con la serie dinámica de BI-MATIC queremos dar respuesta a las necesidades de los clientes para crear muebles de calidad. ¡Cada cortadora de bordes de la serie Prima Plus debe estar siempre lista, gracias a los tiempos de calentamiento reducidos del sistema de encolado, pero sobre todo, puede trabajar cualquier tipo de material! La posibilidad de una personalización casi infinita, la tecnología aplicada, la calidad de los materiales utilizados y la facilidad de uso garantizan un rápido retorno de la inversión.

Não importa qual o material da borda a aplicar, o tipo de cola, a borda coextrudada, com a série dinâmica da BI-MATIC queremos dar uma resposta às necessidades dos clientes para criar mobiliário de qualidade. Cada cantoneira da série Prima Plus deve estar sempre pronta, graças aos tempos de aquecimento reduzidos do sistema de colagem, mas acima de tudo capaz de trabalhar qualquer tipo de material! A possibilidade de personalização quase infinita, a tecnologia aplicada, a qualidade dos materiais utilizados e a facilidade de uso garantem um rápido retorno do investimento.

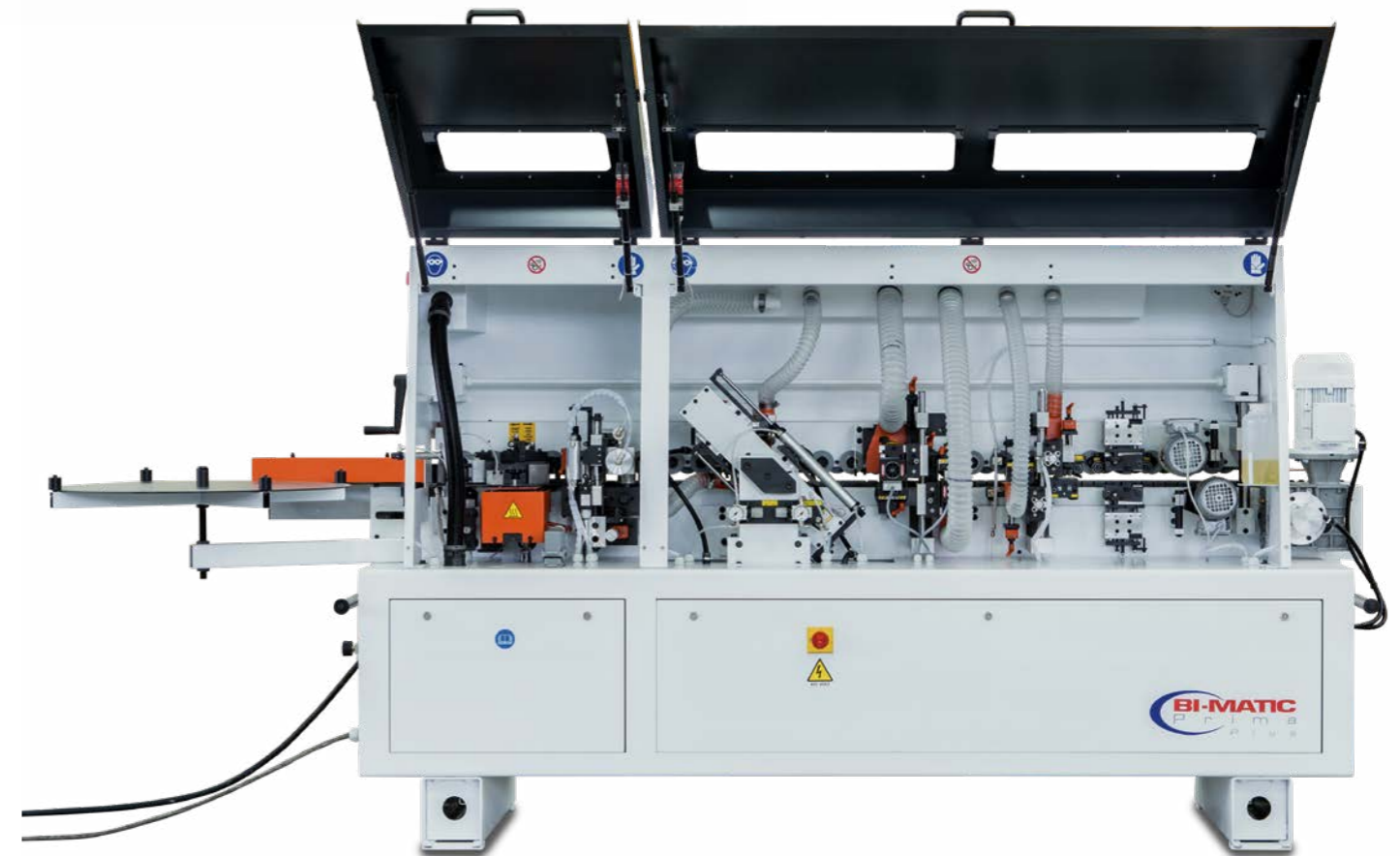



- Guida d'introduzione.
- Feeding guide.
- Einführungshandbuch.
- Guide d'introduction.
- Instructiehandleiding.
- Guía de introducción.
- Guia de introdução.

- Guida d'introduzione con sistema di posizionamento manuale.
- Feeding guide manual positioning system.
- Einführungshandbuch mit manuellem Positionierungssystem.
- Guide d'introduction avec système de positionnement manuel.
- Instructiehandleiding met handmatig positioneringssysteem.
- Guía de introducción con sistema de posicionamiento manual.
- Guia de introdução com sistema de posicionamento manual.

- Guida d'introduzione con sistema di posizionamento motorizzato DIGIT O1.
- Feeding guide motorized positioning system DIGIT O1.
- Positionssteuerung DIGIT O1 für Einlauflineal.
- Guide d'introduction avec système de positionnement motorisé DIGIT O1.
- Instructiehandleiding met gemotoriseerd positionersysteem DIGIT O1.
- Guía de introducción con sistema de colocación motorizado DIGIT O1.
- Guia de introdução com sistema de posicionamento motorizado DIGIT O1.

Standard "ONE" Version

- Sistemi RIEPE LPZ II di nebulizzazione liquidi per la perfetta pulizia dei pannelli.
- RIEPE LPZ II liquid mist systems for perfect cleaning of the panels.
- RIEPE-Flüssignebelsysteme LPZ II für die perfekte Reinigung der Paneele.
- Systèmes de brouillard liquide RIEPE LPZ II pour un nettoyage parfait des panneaux.
- RIEPE LPZ II vloeistofmistsystemen voor een perfecte reiniging van de panelen.
- Sistemas de niebla líquida RIEPE LPZ II para una limpieza perfecta de los paneles.
- Sistemas de névoa líquida RIEPE LPZ II para limpeza perfeita dos painéis.

Optional



- Sistema telescopico sostegno pannelli di grandi dimensioni.
- Telescopic system supporting large panel.
- Teleskopsystem für große Platten.
- Système télescopique supportant de grands panneaux.
- Telescopisch systeem dat grote panelen ondersteunt.
- Sistema telescópico que soporta paneles grandes.
- Sistema telescópico que suporta grandes painéis.

Optional



- Guida d'introduzione pannelli stretti.
- Guide for introducing narrow panels.
- Leitfaden für die Einführung von schmalen Platten.
- Guide pour l'introduction de panneaux étroits.
- Handleiding voor het introduceren van smalle panelen.
- Guía para la introducción de paneles estrechos.
- Guia para a introdução de painéis estreitos.

Optional

- Sistemi RIEPE LP 163/93 di nebulizzazione liquidi per la perfetta pulizia dei pannelli.
- RIEPE LP 163/93 liquid mist systems for perfect cleaning of the panels.
- RIEPE-Flüssignebelsysteme LP 163/93 für die perfekte Reinigung der Paneele.
- Systèmes de brouillard liquide RIEPE LP 163/93 pour un nettoyage parfait des panneaux.
- RIEPE LP 163/93 vloeistofmistsystemen voor een perfecte reiniging van de panelen.
- Sistemas de niebla líquida RIEPE LP 163/93 para una limpieza perfecta de los paneles.
- Sistemas de névoa líquida RIEPE LP 163/93 para limpeza perfeita dos painéis.





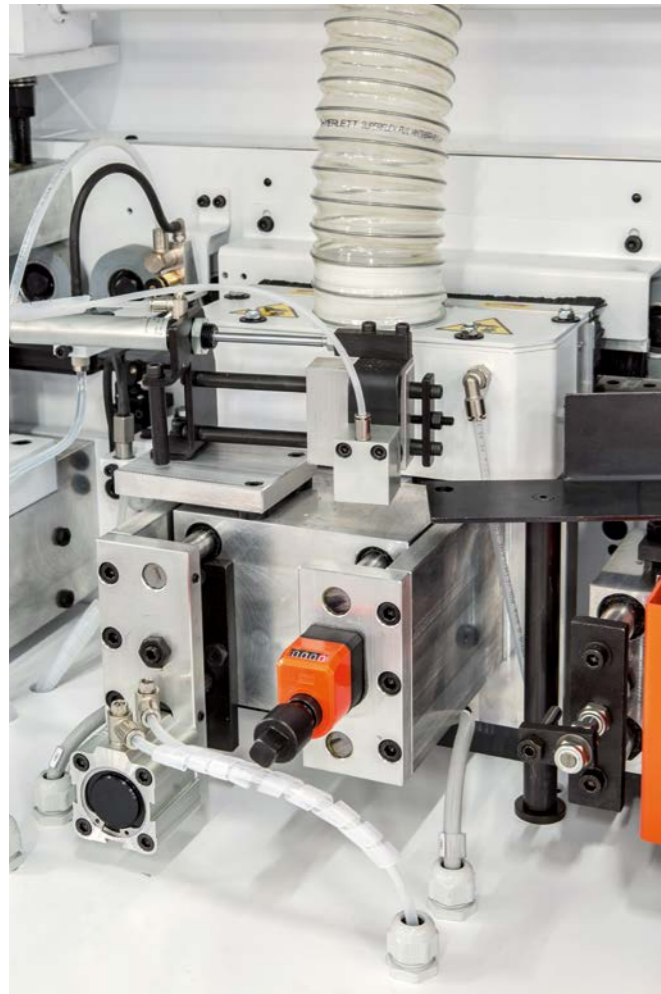

Optional

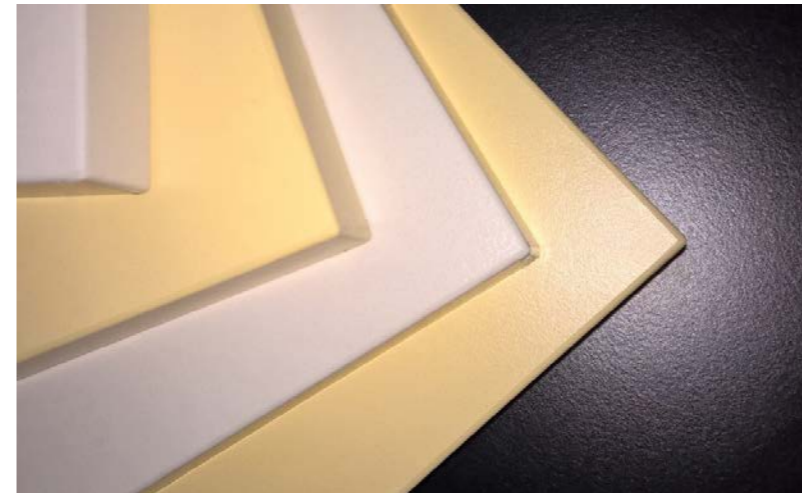



-  Gruppo rettifica a tempo con 2 motori HF a 12.000 g/1'.
-  Timed pre-milling unit HF with 2 motors @ 12.000 rpm.
-  Fügefräsaggregat HF mit 2 Motoren mit 12.000 U/min.
-  Dispositif de rectification temporisé HF à 2 moteurs à 12.000/1'.
-  Getimede voorfreesgroep HF 2 motoren op 12.000 tpm.
-  Grupo toupie en entrada a tiempo HF de 2 motores a 12.000 g/1'.
-  Grupo de rectificação na entrada com 2 motores a 12.000 rpm.









-  Vasca colla da lt. 1,5 con sistema di sgancio rapido (optional); tempo di riscaldamento di 5-6 min.
-  1.5lt glue pot with quick release system (optional); 5-6 min heating up Time.
-  1,5 Lt. Leimbeckeninhalt mit Schnellwechselsystem (optional); Aufheizzeit 5-6 min.
-  Bac à colle de 1,5 lt avec cheangement rapide (optionelle); temps de chauffage de 5- 6 min;
-  Capaciteit liymbak 1,5l met snelkoppelingssysteem (optioneel); opwarmtijd 5-6 min.
-  Capacidad calderin de cola de 1,5 lt con sistema de liberación rápida (optional); tiempo de calentamiento de 5-6 min.
-  Capacidade do deposito de cola de 1,5lt com sistema de liberação rápida (optional); tempo de aquecimento de 5-6 min.









-  Vasca colla da lt. 3; tempo di riscaldamento di 5-6 min.; sistema di sgancio rapido; sistema L-Tec per bordi "coestrusi"
-  3lt glue pot capacity; 5-6 min heating up Time; quick release system; L-Tec system for "coextruded" edges
-  3 Lt. Leimbeckeninhalt; Aufheizzeit 5-6 min.; Schnellverschluss-System; L-Tec System für "coextrudierte" Kanten
-  Bac à colle de 3 lt; temps de chauffage de 5-6 min.; système de changement rapide; Système L-Tec pour les bords "co-extrudés"
-  Capaciteit liymbak 3l; opwarmtijd 5-6 min.; snel ontgrendelsysteem; L-Tec-systeem voor "geco-extrudeerde" randen
-  Capacidad calderin de cola de 3 lt; tiempo de calentamiento de 5-6 min.; sistema de liberación rápida; Sistema L-Tec para bordes "co-extruidos"
-  Capacidade do deposito de cola de 3lt; tempo de aquecimento de 5-6 min.; sistema de liberação rápida; Sistema L-Tec para bordas "coextrudadas"











-  Gruppo traversa con sistema di posizionamento manuale.
-  Supporting cross member unit with manual positioning system.
-  Positionssteuerung mit manueller Andruckzone.
-  Groupe traverse avec système de positionnement manuel.
-  Dwarsligger met handmatig positioneringssysteem.
-  Grupo travesaño con sistema de colocación manual.
-  Grupo travessa com sistema de posicionamento manual.



-  Gruppo traversa con sistema di posizionamento DIGIT 01.
-  Supporting cross member unit with DIGIT 01 positioning system.
-  Positionssteuerung mit DIGIT 01 Andruckzone.
-  Groupe traverse avec système de positionnement DIGIT 01.
-  Dwarsligger met DIGIT 01 positioneringssysteem.
-  Grupo travesaño con sistema de colocación DIGIT 01.
-  Grupo travessa com sistema de posicionamento DIGIT 01.

Optional







-  Sistema pneumatico per l'inclinazione del gruppo Intestatore, dal pannello di comando.
-  Pneumatic system to slant End Trimming Unit from control panel.
-  Pneumatisch schwenkbares Kappsägeaggregat, vom Bedienpult anwählbar.
-  Système pneumatique pour l'inclinaison du groupe Coupe en bout, à partir du panneau de commande.
-  Pneumatisch systeem voor schuinstelling van de zaaggroep vanop het bedieningspaneel.
-  Sistema neumático para la inclinación del grupo Retestador, del panel de mando.
-  Sistema pneumático para a inclinação do grupo Retestador, a partir do painel de comando.

Optional

-  Gruppo intestatore verticale 2 motori a 12.000 g/1', inclinabile da 0° a 15°.
-  Vertical butting unit with 2 motors @12.000 rpm, chamfer from 0° to 15°.
-  Sägekappaggregat mit 2 Motoren á 12.000 U/min., schwenkbar von 0° bis 15°.
-  Coupe en bout verticale à 2 moteurs à 12.000 T/1', inclinable de 0° à 15°.
-  Verticale zaaggroep met 2 motoren op 12.000 tpm, schuinstelbaar van 0° tot 15°.
-  Grupo retestador vertical 2 motores a 12.000 g/1', inclinable de 0° a 15°.
-  Grupo retestador com dois discos verticais a 12.000 rpm, inclinável de 0° até 15°.



-  Gruppo refillatore HF 12.000 g/1'.
-  Edge Trimming unit HF @ 12.000 rpm.
-  Bündigfräsaggregat neigbar mit 2 Motoren á 12.000 U/min.
-  Dispositif d'affleurage HF 12.000 T/1'.
-  Rand Trimeenheid HF @ 12.000 tpm.
-  Grupo refillador HF 12.000 g/1'.
-  Grupo afagador de 12.000 rpm.



-  Gruppo refillatore HF 12.000 g/1' con PN 02.
-  PN 02 Edge Trimming unit HF @ 12.000 rpm.
-  Bündigfräsaggregat mit PN 02 neigbar mit 2 Motoren á 12.000 U/min.
-  Dispositif d'affleurage vec PN 02 HF 12.000 T/1'.
-  Rand Trimeenheid met PN 02 HF @ 12.000 tpm.
-  Grupo refillador con PN 02 HF 12.000 g/1'.
-  Grupo afagador com PN 02 de 12.000 rpm.







Optional
Standard "PNE" Version









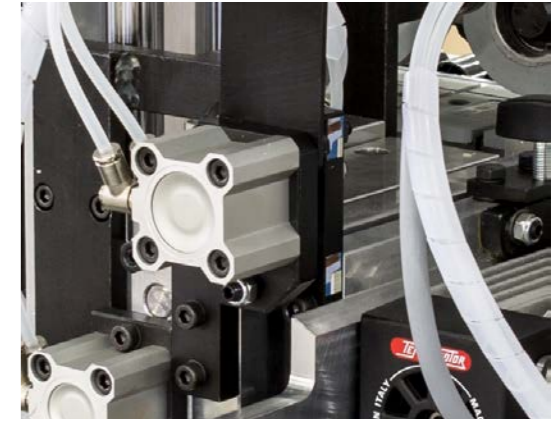

-  Gruppo refillatore HF 12.000 g/1' con DIGIT 02.
-  DIGIT 02 Edge Trimming unit HF @ 12.000 rpm.
-  Bündigfräsaggregat mit DIGIT 02 neigbar mit 2 Motoren á 12.000 U/min.
-  Dispositif d'affleurage vec DIGIT 02 HF 12.000 T/1'.
-  Rand Trimeenheid met DIGIT 02 HF @ 12.000 tpm.
-  Grupo refillador con DIGIT 02 HF 12.000 g/1'.
-  Grupo afagador com DIGIT 02 de 12.000 rpm.

Optional
Standard "ONE" Version



-  Gruppo arrotondatore A-PRO2 a 1 motore HF a 12.000 g/1' per la lavorazione degli spigoli.
-  A-PRO2 Contour Trimming Unit 1 motor @ 12.000 rpm for edge processing.
-  Abrundaggregat Typ A-PRO2 mit 1 Motore mit 12.000 U/min. für die Kopfkantenbearbeitung.
-  Dispositif d'arrondissement A-PRO2 avec 1 moteur à 12.000 T/1' pour l'usinage des têtes.
-  Afrondfreesgroep A-PRO2 met 1 motore op 12.000 tpm voor de bewerking van de hoeken.
-  Grupo redondeador A-PRO2 con 1 motor 12.000 g/1' para la elaboración de las cabezas.
-  Grupo arredondador A-PRO2 com 1 motor de 12.000 rpm para trabalhar as extremidades do painel.



-  Sistema pneumatico PN 02, dal pannello di comando.
-  Pneumatic system PN 02 from control panel.
-  Pneumatisch PN 02 vom Bedienpult anwählbar.
-  Système pneumatique PN 02 à partir du panneau de commande.
-  Pneumatisch systeem PN 02 vanop het bedieningspaneel.
-  Sistema neumático PN 02 del panel de mando.
-  Sistema pneumático PN 02 a partir do painel de comando.

Optional









-  Gruppo raschiatore.
-  Scraper unit.
-  Ziehklingenaggregat.
-  Dispositif de raclage.
-  Schraapgroep.
-  Grupo rascador.
-  Grupo raspador.



-  On/Off pneumatico, dal pannello di comando.
-  Pneumatic On/Off system from control panel.
-  Pneumatisch On/Off vom Bedienpult anwählbar.
-  Système pneumatique On/Off à partir du panneau de commande.
-  Pneumatisch systeem On/Off vanop het bedieningspaneel.
-  Sistema neumático On/Off del panel de mando.
-  Sistema neumático On/Off a partir do painel de comando.







Optional



-  Gruppo raschiatore PN 02 con nebulizzatore di liquido anti-adessivo.
-  PN 02 Scraper unit with sprinker for anti-adhesive liquid.
-  Ziehklingenaggregat mit PN 02 mit Trennmittelsprüheinrichtung.
-  Dispositif de raclage avec PN 02 avec diffuseur de liquide anti-adhésif.
-  Schraapgroep met PN 02 met vernevelaar van anti-kleefvloeistof.
-  Grupo rascador con PN 02 con pulverizador de líquido anti-adhesivo.
-  Grupo raspador con PN 02 con pulverizador de líquido antiadesivo.

Optional
Standard "PNE" Version







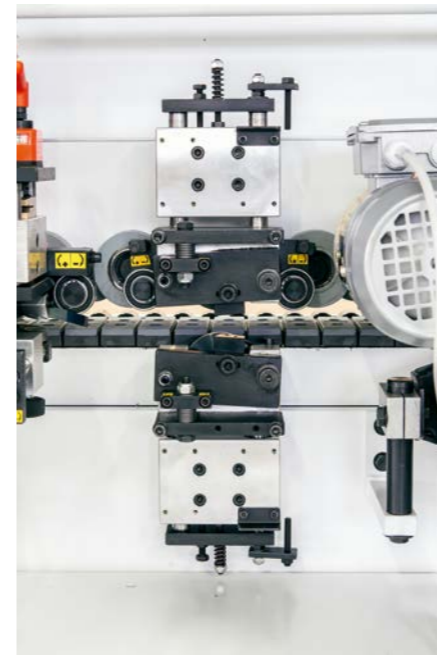

-  Gruppo raschiatore DIGIT 02 con nebulizzatore di liquido anti-adessivo.
-  DIGIT 02 Scraper unit with sprinker for anti-adhesive liquid.
-  Ziehklingenaggregat DIGIT 02 mit Trennmittelsprüheinrichtung.
-  Dispositif de raclage DIGIT 02 avec diffuseur de liquide anti-adhésif.
-  Schraapgroep DIGIT 02 met vernevelaar van anti-kleefvloeistof.
-  Grupo rascador DIGIT 02 con pulverizador de líquido anti-adhesivo.
-  Grupo raspador DIGIT 02 con pulverizador de líquido antiadesivo.

Optional
Standard "ONE" Version









-  Gruppo raschiacolla.
-  Glue Scraper unit.
-  Flachziehklingenaggregat.
-  Dispositif de raclage de la colle.
-  Lijmschraapgroep.
-  Grupo rascador de cola.
-  Grupo raspador de cola.



-  Gruppo raschiacolla con On/Off pneumatico.
-  Glue Scraper unit + pneumatic On/Off.
-  Flachziehklingenaggregat + Pneumatisch On/Off vom Bedienpult anwählbar.
-  Dispositif de raclage de la colle + Système pneumatique On/Off à partir du panneau de commande.
-  Lijmschraapgroep + Pneumatisch systeem On/Off vanop het bedieningspaneel.
-  Grupo rascador de cola + Sistema neumático On/Off del panel de mando.
-  Grupo raspador de cola + Sistema neumático On/Off a partir do painel de comando.

Optional



-  Gruppo spazzolatore a 3.000 g/1' per la pulizia dei bordi.
-  Buffing unit @ 3.000 rpm for edge cleaning.
-  Schwabbelaggregat mit 2 Motoren á 3.000 U/min. zur Reinigung der Kanten.
-  Dispositif de brossage à 3.000 T/1' pour le nettoyage des bords.
-  Borstelgroep op 3.000 tpm voor de reiniging van de boorden.
-  Grupo pulidor a 3.000 g/1' para la limpieza de los bordes.
-  Grupo de escovas para limpeza de orlas de 3.000 rpm.

Kit Nesting

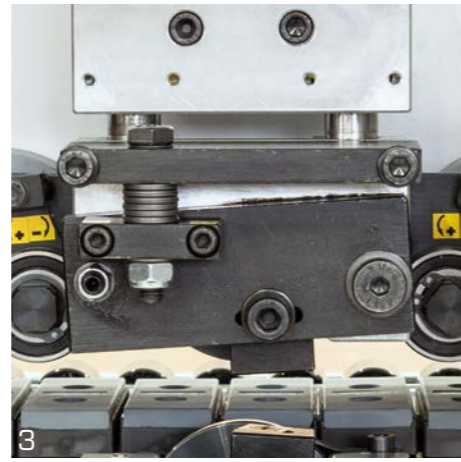
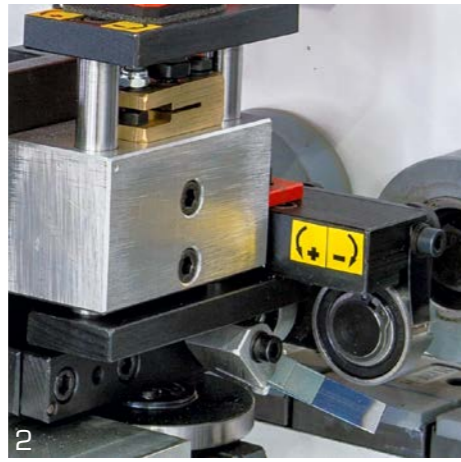

Refilatore.

Raschiabordo.

Raschiacolla.

Edge Trimmer.

Scraper.

Glue Scraper.

Bündigfräsaggregat.

Ziehklingenaggregat.

Flachziehklingenaggregat.

Affleurage.

Raclage.

Raclage de la colle.

Trimeenheid.

Schraapgroep.

Lijmschraapgroep.

Refilador.

Rascador.

Rascador de cola.

Afagador.

Raspador.

Raspador de cola.

Optional

Optional

Optional

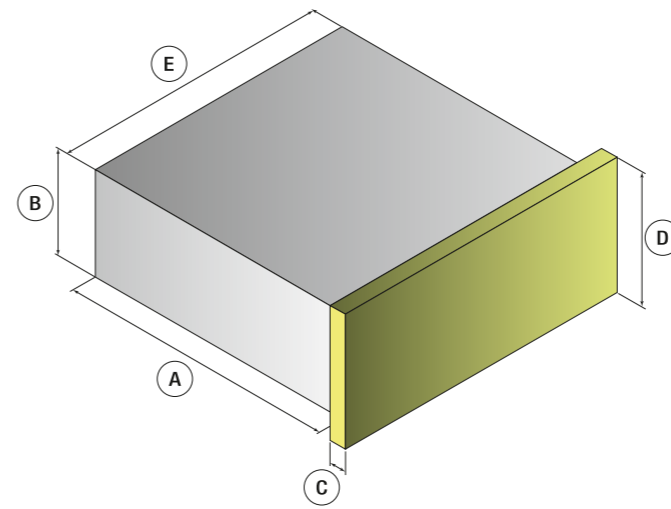

A	60 / 95** mm	2.36 / 3.74** in
B min	B min 8 / 12 mm	0.31 / 0.47 in
B max	B max 40 / 50*** mm	1.57 / 1.97*** in
C min	C min 0,4 mm	0,016 in
C max	C max 3 / 5*** mm	0.12-0.20*** in
D	D 55 mm	2.17 in
E	E 80 / 300** mm	3.15 / 11.81 ** in
bar	6	6
	9 mt/1'	29.5 ft/1'

* con rettifica, with pre-milling, mit Fügefräsaggregat, avec rectification, met voorfreesgroep, com tupi en entrada, com rectificação
 ** con arrotondatore, with rounder, mit Abrundaggregat, avec arrondisseur, met afrondfreesgroep, com redondeador, com arredondador
 *** optional, optionals, auf Wunsch, options, opties, optionale, opcional

EMISSIONE SONORA Il valore è indicativo	NOISE LEVEL Approximate value	GERÄUSCHPEGEL Näherungskiert	EMISSION SONORE Valeur indicative	GELUIDSSTERKTE Indicatieve waarde	EMISIÓN SONORA El valor es indicativo	EMISSÃO ACÚSTICA O valor é indicativo
db 65-72						

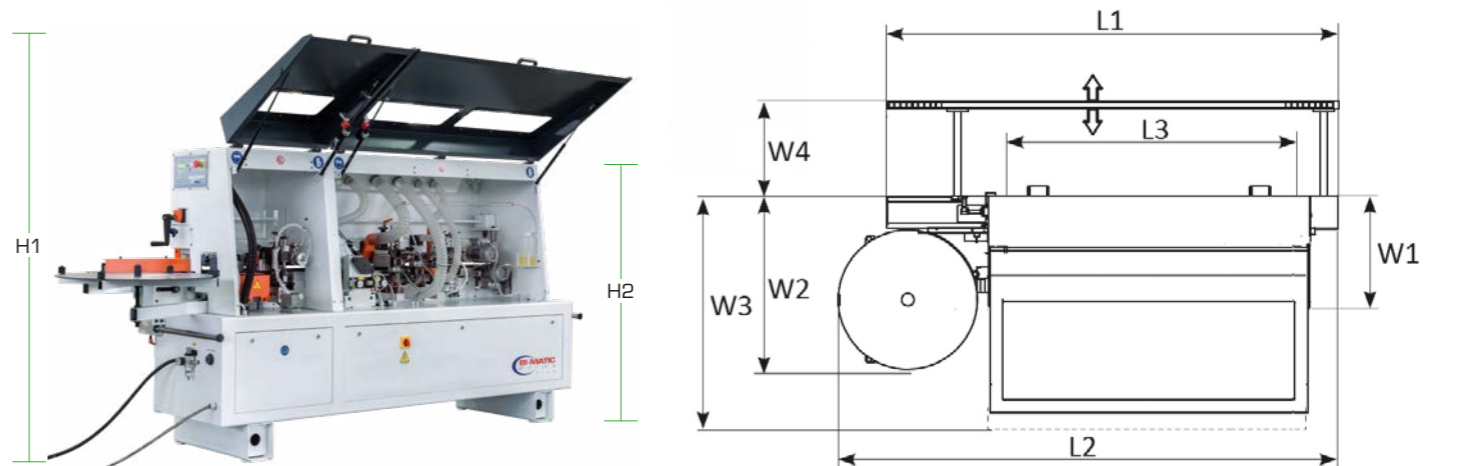

	3.3 Plus	4.3 Plus	5.3 Plus	4.3 - r. Plus	5.3 - r. Plus	6.3 - r. Plus	6.3 - r.a. Plus	7.3 - r.a. Plus
L 1	2.350 mm 6.89 ft	2.550 mm 7.55 ft	2.700 mm 8.85 ft	2.850 mm 8.53 ft	3.150 mm 9.19 ft	3.300 mm 10.83 ft	3.950 mm 12.96 ft	4.250 mm 13.94 ft
L 2	2.550 mm 7.55 ft	2.750 mm 8.20 ft	2.900 mm 9.50 ft	3.050 mm 9.19 ft	3.350 mm 9.84 ft	3.500 mm 11.48 ft	4.150 mm 13.62 ft	4.450 mm 14.60 ft
L 3	1.400 mm 4.59 ft	1.600 mm 5.25 ft	1.750 mm 5.75 ft	1.900 mm 6.23 ft	2.200 mm 6.89 ft	2.350 mm 7.71 ft	2.800 mm 9.19 ft	3.100 mm 10.17 ft
H 1	1.850 mm 6.07 ft	1.850 mm 6.07 ft	1.850 mm 6.07 ft	1.850 mm 6.07 ft	1.850 mm 6.07 ft	1.850 mm 6.07 ft	2.000 mm 6.56 ft	2.000 mm 6.56 ft
H 2	1.300 mm 4.27 ft	1.300 mm 4.27 ft	1.300 mm 4.27 ft	1.300 mm 4.27 ft	1.300 mm 4.27 ft	1.300 mm 4.27 ft	1.400 mm 4.59 ft	1.400 mm 4.59 ft
W 1	600 mm 1.97 ft	600 mm 1.97 ft	600 mm 1.97 ft	600 mm 1.97 ft	600 mm 1.97 ft	600 mm 1.97 ft	700 mm 2.30 ft	700 mm 2.30 ft
W 2	800 mm 2.62 ft	800 mm 2.62 ft	800 mm 2.62 ft	800 mm 2.62 ft	800 mm 2.62 ft	800 mm 2.62 ft	800 mm 2.62 ft	800 mm 2.62 ft
W 3	900 mm 2.95 ft	900 mm 2.95 ft	900 mm 2.95 ft	900 mm 2.95 ft	900 mm 2.95 ft	900 mm 2.95 ft	900 mm 2.95 ft	900 mm 2.95 ft
W 4	600 mm 1.97 ft	600 mm 1.97 ft	600 mm 1.97 ft	600 mm 1.97 ft	600 mm 1.97 ft	600 mm 1.97 ft	600 mm 1.97 ft	600 mm 1.97 ft
	430 kg 950 lbs	440 kg 970 lbs	460 kg 1.020 lbs	610 kg 1.350 lbs	640 kg 1.420 lbs	680 kg 1.500 lbs	1.100 kg 1.990 lbs	1.200 kg 2.650 lbs
	5,5 Kw 6 Amp	5,5 Kw 6 Amp	5,5 Kw 6 Amp	7,5 Kw 8 Amp	7,5 Kw 8 Amp	7,5 Kw 8 Amp	8,5 Kw 9 Amp	8,5 Kw 9 Amp



I dati tecnici e le caratteristiche indicate nel presente catalogo non sono impegnative e possono subire modifiche senza alcun preavviso.
Le immagini possono mostrare anche opzioni e non sono vincolanti per quanto riguarda l'ordine. Soggetto a modifiche.



All technical data and specifications as quoted in this catalogue are not binding and may be varied without prior notice.
Images may show also options and are not binding in regard to the order. Subject to changes.



Die technischen Daten und Eigenschaften im vorliegenden Katalog sind unverbindlich und können ohne Vorankündigung verändert werden.
Bilder können auch Optionen anzeigen und sind in Bezug auf die Bestellung nicht bindend. Änderungen vorbehalten.



Les données techniques et les caractéristiques indiquées dans le présent catalogue n'engagent en rien le fabricant et peuvent subir des modifications sans aucun préavis.
Les images peuvent également montrer des options et ne sont pas contraignantes en ce qui concerne la commande. Sous réserve de modifications.



Alle technische gegevens en specificaties vermeld in deze catalogus zijn niet bindend en kunnen aangepast worden zonder voorafgaande kennisgeving.
Afbeeldingen kunnen ook opties tonen en zijn niet bindend met betrekking tot de bestelling. Onder voorbehoud van wijzigingen.



Los datos técnicos y las características indicadas en el presente catálogo no son vinculables y pueden sufrir modificaciones sin previo aviso.
Las imágenes también pueden mostrar opciones y no son vinculantes en relación con el orden. Sujeto a cambios.



Os dados técnicos e as características indicadas no presente catálogo não constituem compromisso e podem sofrer modificações sem qualquer aviso prévio.
As imagens também podem mostrar opções e não são vinculativas em relação ao pedido. Sujeito a alterações.

BI-MATIC
WOODWORKING MACHINERY

BI-MATIC S.r.l.

Via La Valle, 23
22066 - Mariano Comense (CO)
ITALIA

Tel. +39-031-751.983 r.a.
Fax +39-031-751.984
e-mail: bi-matic@bi-matic.it
web site: www.bi-matic.it

